

## MD 310 C K16

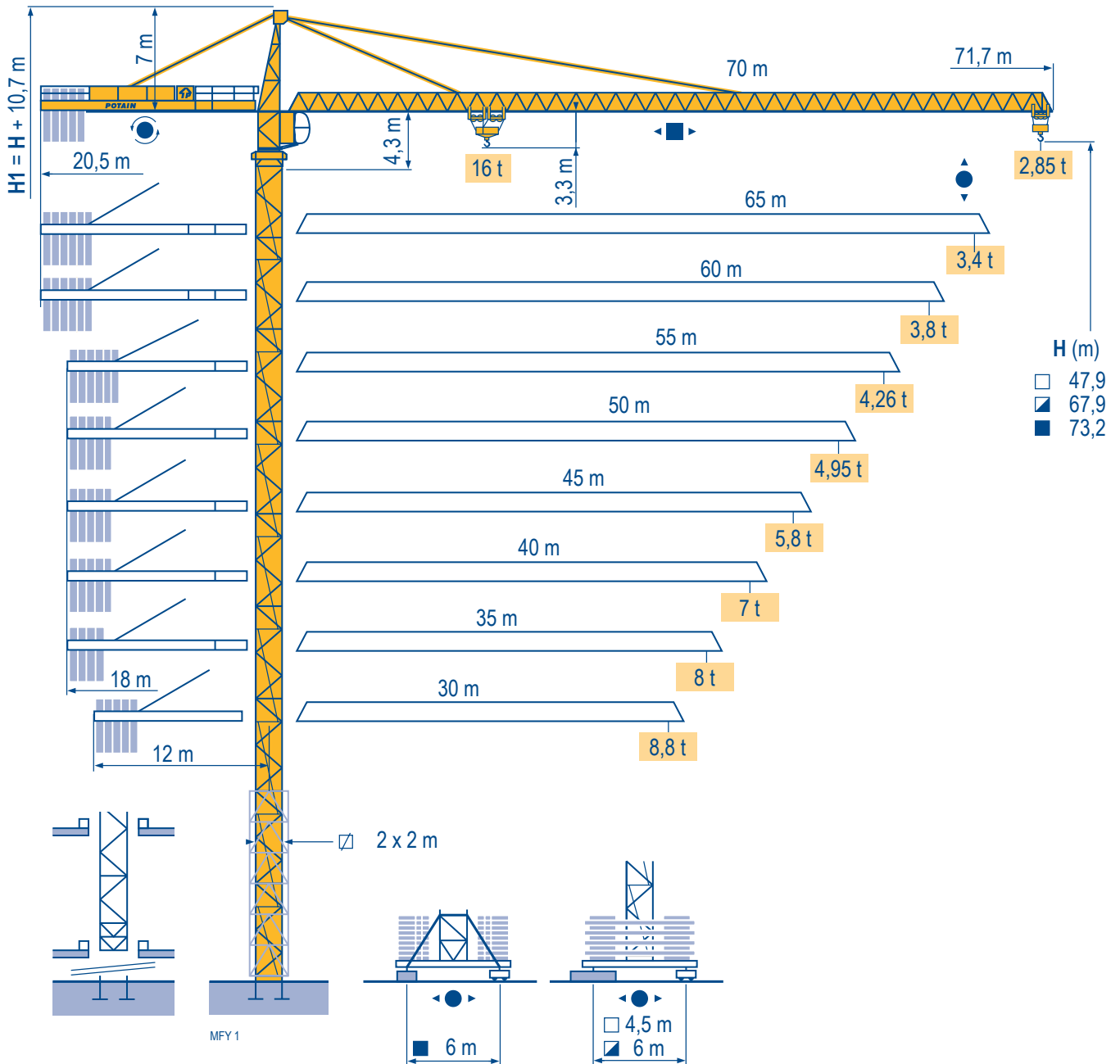

### TOPKIT

Mat / Reações  $\square$  2 m

Maste / Eckdrücke  $\blacktriangle$  30 m  $\Rightarrow$  70 m

Masts / Reactions  
Mástil / Reacciones  
Torre / Reazioni  
Tramo / Reações  
Композиции башни / Реакции

MFY 1

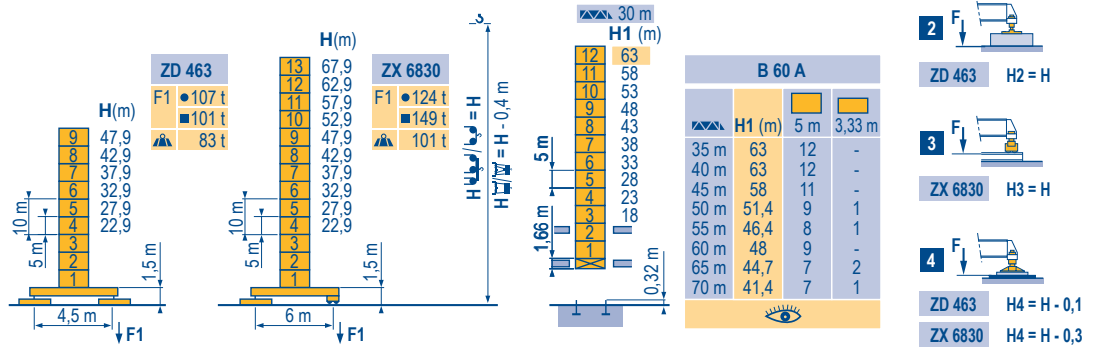
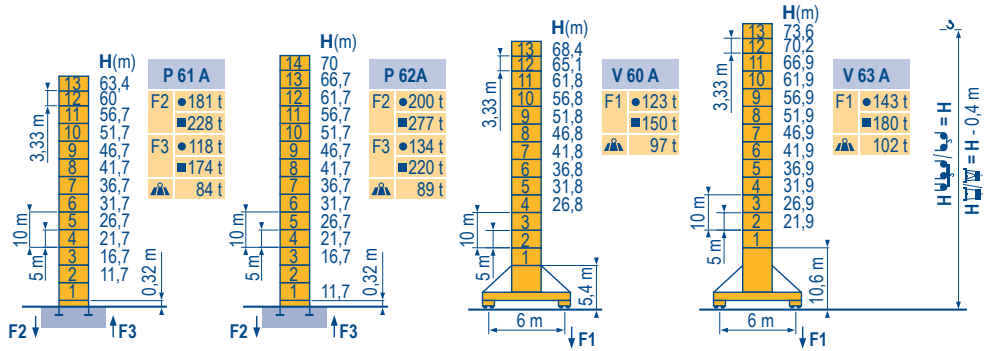

Télescopage sur dalles  
Kletterkrane im Gebäude  
Climbing crane  
Telescopage gruas trepadoras  
Gru in cavedio  
Telescopagem sobre lages  
Кран, ползущий внутри здания

MFY 1

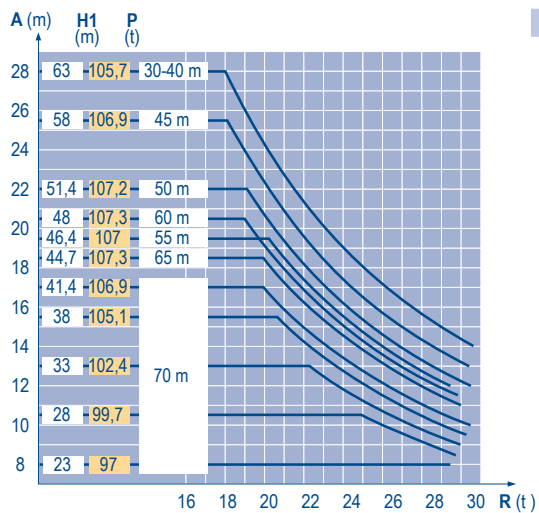
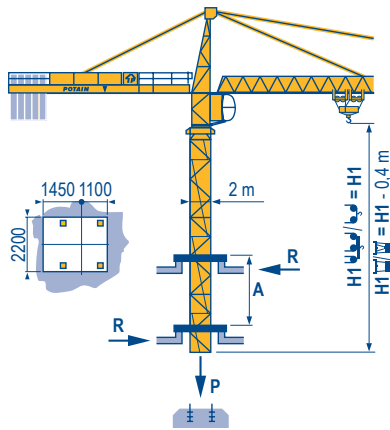

TOPKIT  
MD 310 C K16

POTAIN

	FR	DE	EN	ES	IT	PT	RU
	Réactions en service	Reaktionskräfte in Betrieb	Reactions in service	Reacciones en servicio	Reazioni in servizio	Reações em serviço	Реакции при работе
	Réactions hors service	Reaktionskräfte außer Betrieb	Reactions out of service	Reacciones fuera de servicio	Reazioni fuori servizio	Reações fora de serviço	Реакции в покое
	A vide sans lest (ni train de transport) avec flèche et hauteur maximum.	Ohne Last, Ballast (und Transportachse), mit Maximalausleger und Maximalhöhe.	Without load, ballast (or transport axes), with maximum jib and maximum height.	Sin carga, sin lastre, (ni tren de transporte), flecha y altura máxima.	A vuoto, senza zavorra (ne assali di trasporto) con braccio massimo e altezza massima.	Sem carga (nem trem de transporte) - sem lastro com lança e altura máximas.	Вес без груза, балласта (или транспортных осей), с максимальной длиной стрелы и максимальной высотой.
	Nous consulter	Auf Anfrage	Consult us	Consultarnos	Consultateci	Consultar-nos	Проконсультируйтесь у нас



Mécanismes  
Antriebe  
Mechanisms  
Meccanismi  
Mecanismos  
Механизмы

MFY 1

		↙ ↑				↘ ↑				ch - PS hp	kW	
↑	75 LVF 40 Optima	m/min	0 → 33,8 → 44 → 62 → 90	0 → 16,9 → 22 → 31 → 45	75	55	637 m					
	t	8 6 4 2	16 12 8 4									
	100 LVF 40 Optima	m/min	0 → 43,8 → 56 → 76 → 116	0 → 21,9 → 28 → 348 → 58	100	75	1136 m					
t	8 6 4 1,4	16 12 8 2,8										
	150 LCC 40	m/min	70,2 → 84 → 106 → 140 → 168	35,1 → 42 → 53 → 70 → 84	150	110	1092 m					
t	8 6 4 2 1	16 12 8 4 2										
◀ ▶	6 DVF 6	m/min	0 → 42(16 t) 0 → 84 (8 t) 0 → 100 (4 t)		5,5	4						
	RVF 162 Optima +	tr/min U/min rpm	0 → 0,7			2 x 7,5	2 x 5,5					
	V 60 A RT 544 A1 2V R ≥ 13 m	m/min	13,5 - 27			4 x 7	4 x 5,2					
	V 63 A											
	ZX 6830 RT 664 A2B 2V	m/min	16 - 32			6 x 7	6 x 5,2					
CEI 38		IEC 38		kVA								
400 V (+6% -10%) 50 Hz				75 LVF : 100 kVA 100 LVF : 125 kVA 150 LCC : 175 kVA								

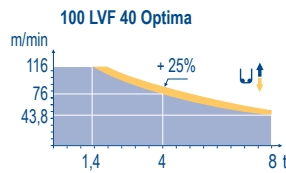
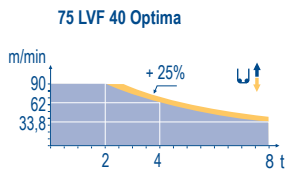

	FR	DE	EN	ES	IT	PT	RU
	Levage	Heben	Hoisting	Elevación	Sollevarmento	Elevação	Подъем
	Distribution	Katzfahren	Trolleying	Distribución	Distribuzione	Distribuição	Перемещение каретки
	Orientation	Schwenken	Slewing	Orientación	Rotazione	Rotação	Поворот
	Translation	Kranfahren	Travelling	Traslación	Traslazione	Translação	Перемещение крана

Document commercial non contractuel. Pour toute information technique se référer à la notice correspondante. Unverbindliches Vertriebsdokument. Für technische Informationen, siehe die entsprechenden Anweisungen. This commercial document is not legally binding. For any technical information, please refer to the corresponding instructions. Documento comercial no contractual. Para cualquier información técnica, ver la noticia correspondiente. Documento commerciale non vincolante, per tutte le informazioni tecniche fare riferimento al catalogo istruzioni. Documento comercial não contractual. Para qualquer informação técnica complementar consultar as respectivas instruções. Этот коммерческий документ не является юридически обязательным. Для получения технической информации, см. соответствующие инструкции.



**Americas**  
Tel : +1 888 479 7278  
Tel : +1 717 593 2000

**Europe – Middle East – Africa**  
Tel : +33 (0) 4 72 81 50 00  
Tel : +44 (0) 191 522 2000

**Asia – Pacific**  
Tel : +65 6264 1188  
Fax : +65 6862 4040

www.manitowoccranes.com

18, rue de Charbonnières - B.R.173  
69132 ECULLY Cedex - France

Tél. : +33 (0) 4 72 18 20 20  
Fax. : +33 (0) 4 72 18 20 00  
www.manitowoccranes.com

**TOPKIT MD 310 C K16**  
Réf. 2008 18 MFY 2

Copyright.Reproduction interdite © POTAIN 2008